

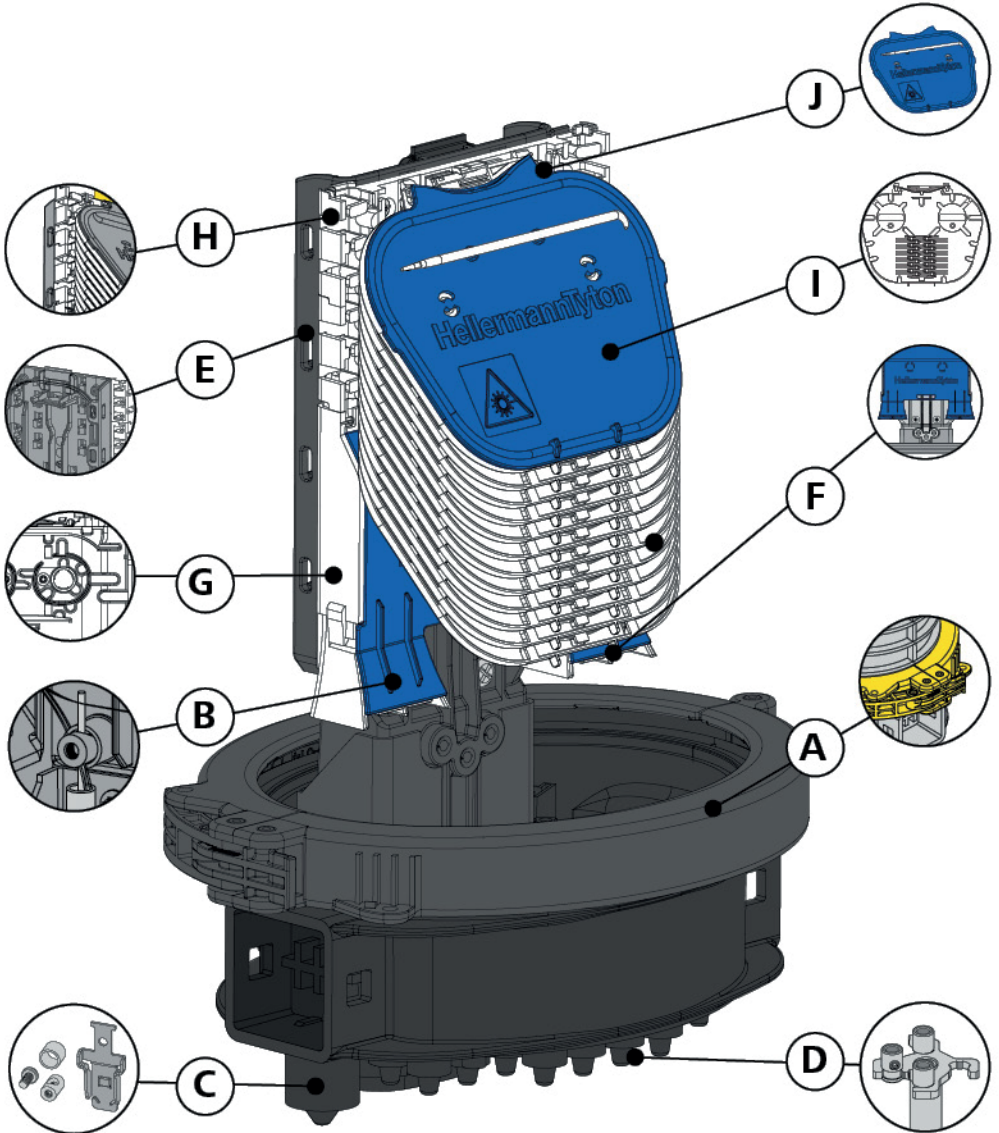

COMPACT FIBRE NODE (CFN)





R PORT BASE

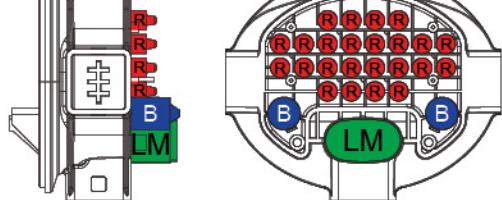

Port	Number of Ports	Cablelok		Heatshrink	
		Ø mm	Ø inches	Ø mm	Ø inches
LM	1	2 x 4.0 - 15.0	2 x 0.16 - 0.59	2 x 8.0 - 22.0	2 x 0.32 - 0.87
B	2	4.8 - 16.5	0.19 - 0.65	6.0-19.0	0.24 - 0.75
R	24	1.7 - 9.5	0.07 - 0.37	-	-

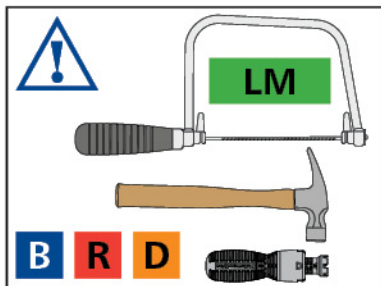

Ø (mm)	Ø (Inches)	Cablelok
2 x 4.0 - 6.5	2 x 0.16 - 0.26	LM10C
2 x 6.0 - 9.5	2 x 0.24 - 0.37	LM20C
2 x 9.0 - 12.5	2 x 0.35 - 0.49	LM30C
2 x 12.5 - 15.0	2 x 0.49 - 0.59	LM40C

D PORT BASE

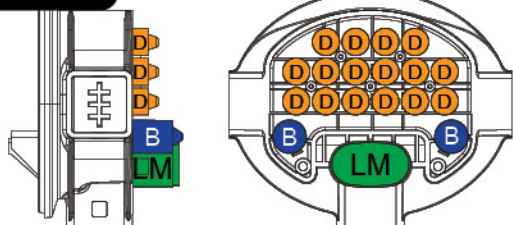

Port	Number of Ports	Cablelok		Heatshrink	
		Ø mm	Ø inches	Ø mm	Ø inches
LM	1	2 x 4.0 - 15.0	2 x 0.16 - 0.59	2 x 8.0 - 22.0	2 x 0.32 - 0.87
B	2	4.8 - 16.5	0.19 - 0.65	6.0-19.0	0.24 - 0.75
D	16	10-12	0.39-0.47	-	-

Ø (mm)	Ø (Inches)	Cablelok
4.8 - 9.0	0.19 - 0.35	B10
8.0 - 14.0	0.32 - 0.55	B20
13.0 - 16.5	0.51 - 0.65	B30

Ø (mm)	Ø (Inches)	Cablelok
1.7 - 2.0	0.07 - 0.079	R10
2 x 1.7 - 2.0	2 x 0.07 - 0.079	R10D
2.0 - 3.0	0.07 - 0.119	R15
3.0 - 3.8	0.119 - 0.15	R20
2 x 3.8 - 4.8	2 x 0.15 - 0.19	R30D
3.8 - 5.2	0.19 - 0.20	R40
5.2 - 8.0	0.20 - 0.32	R50
6.0 - 8.5	0.24 - 0.34	R70
8.0 - 9.5	0.32 - 0.37	R80

Ø (mm)	Ø (Inches)	Cablelok
10	0.39	D10
12	0.47	D20

Port - port - Anschluß - Port - puerto - porto - porta - Port - Port
 - Port - Racord - port - poort

Number of Ports - Nombre de ports - Anzahl der Anschlüsse -
 Antal portar - Número de puertos - Número de portas - Numero
 di porte - Portok száma - Numar racorduri - Počet portů - Antall
 porter - Števílo portov - Aantal poorten

Heatshrink - Thermo rétractable - Wärmeschrumpfschlauch -
 Krymslang - Termoretráctil - Termoretráteis - Termorestringente
 - Zsugorósó - Termocontractibil - Teplim smršťitelné hadice -
 krimpstrampe - toploskrčva cev - Krimpkaus

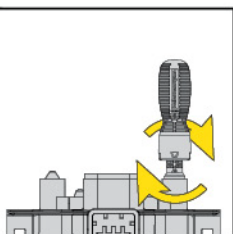
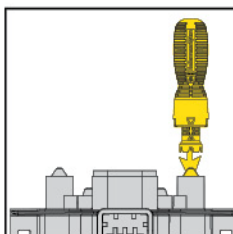
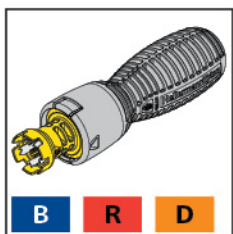
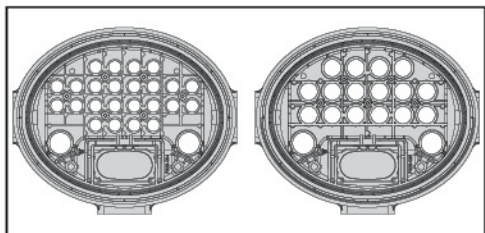
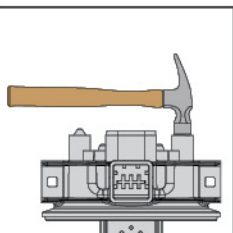
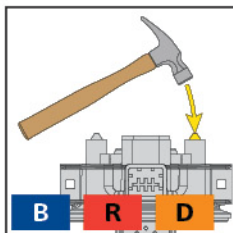
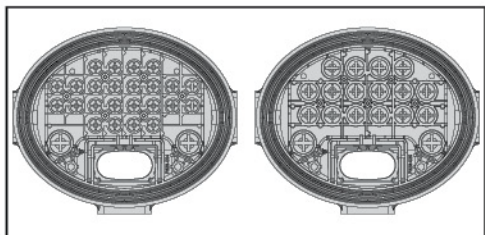
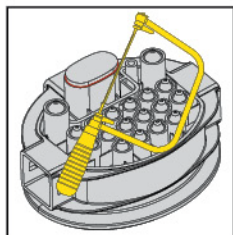
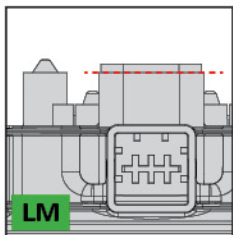

A

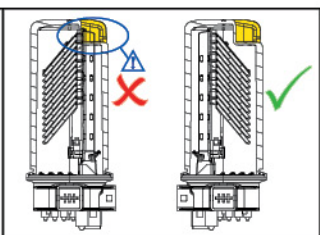
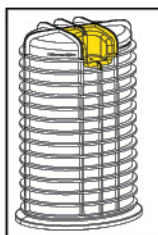
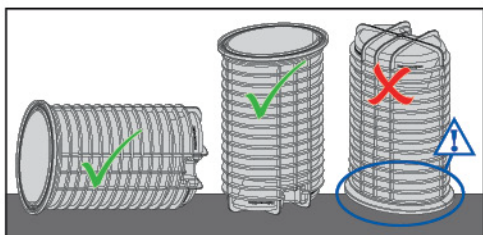
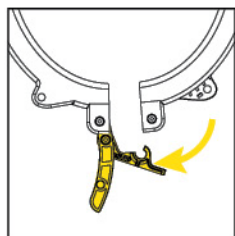
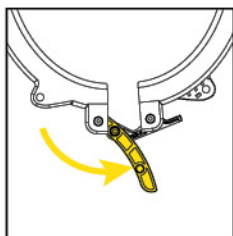
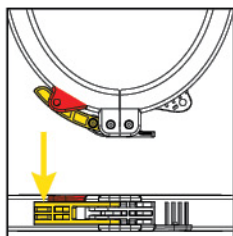
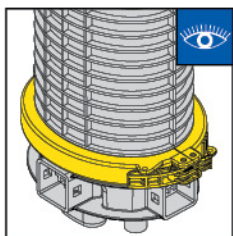

B contd

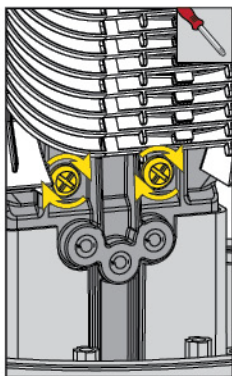

C

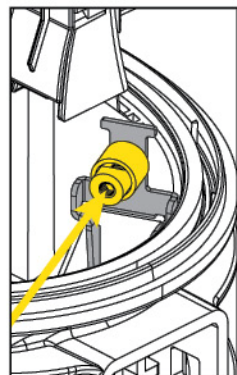
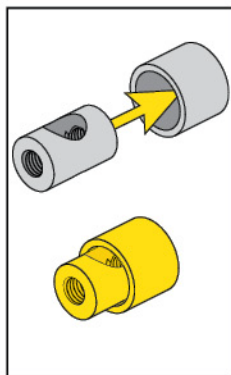
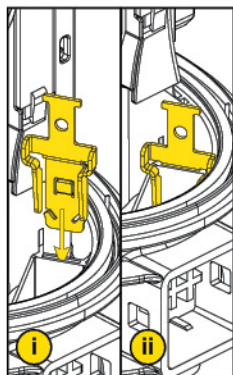
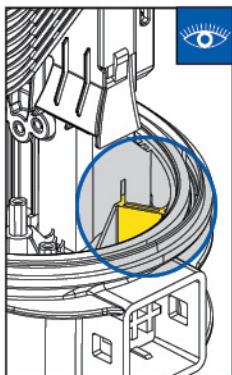
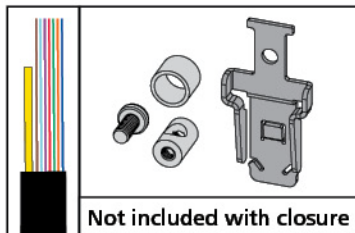
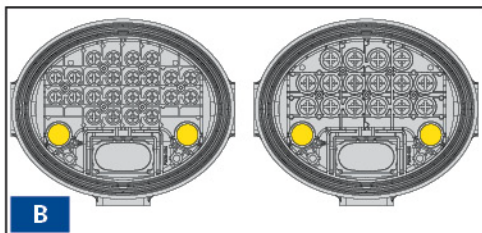



1 Cablelok Loop

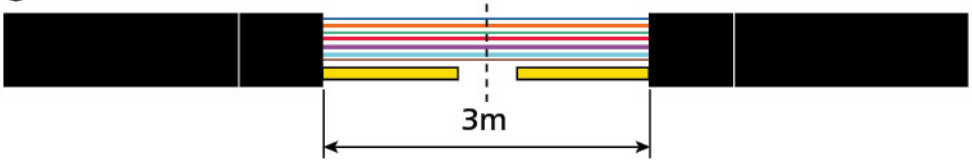

2 Cablelok

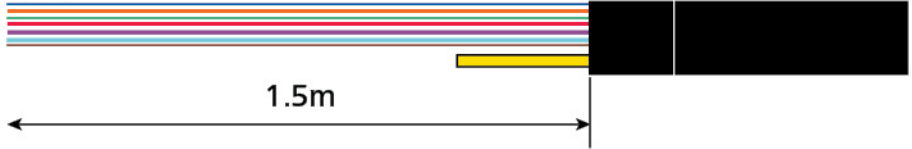

B

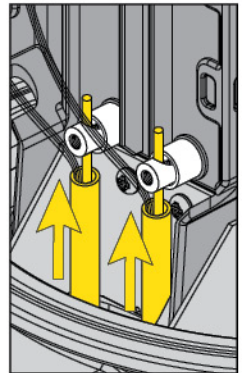
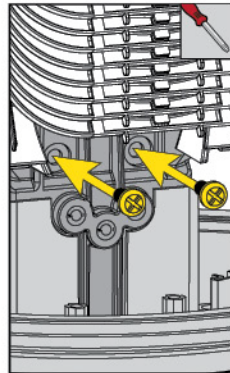
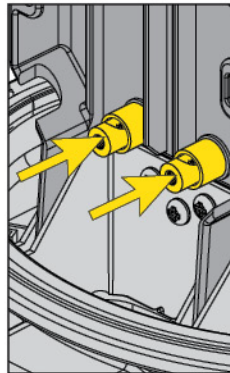
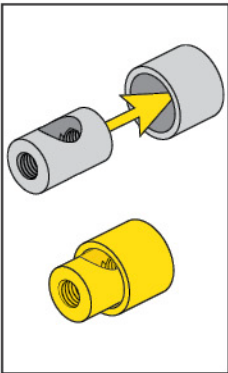
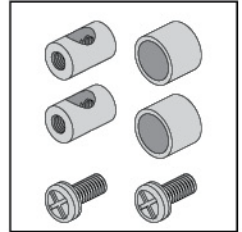
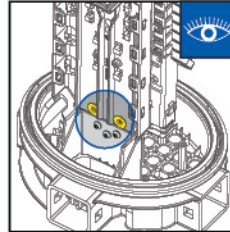
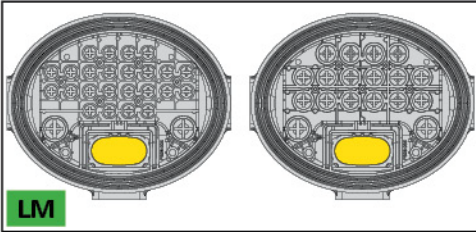

D contd

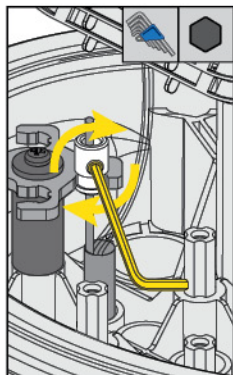
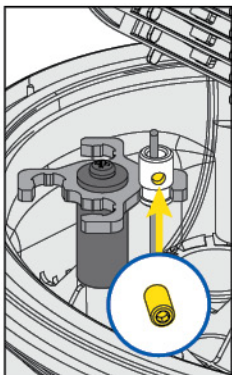
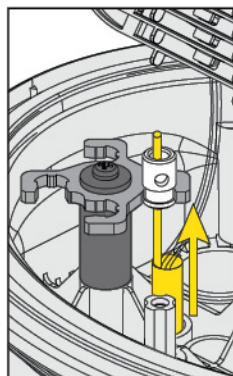
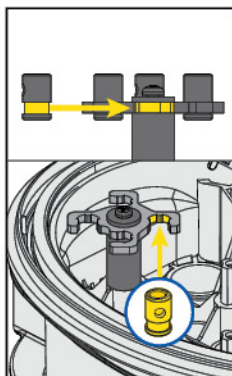
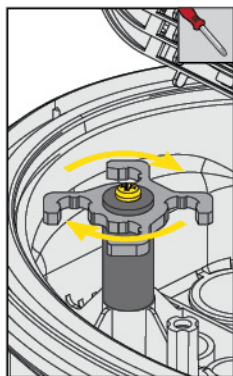
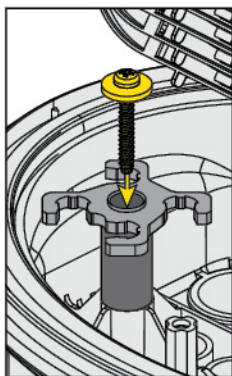

E

S Length

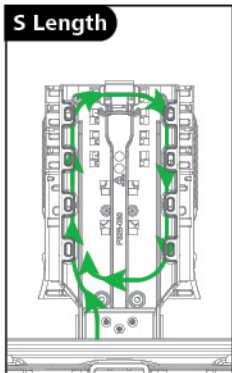

M Length

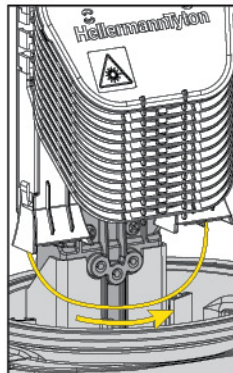
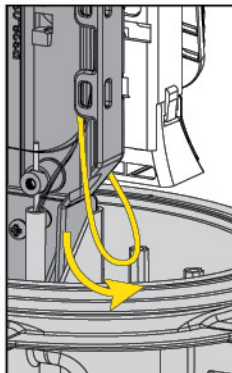
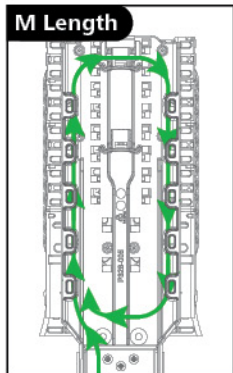

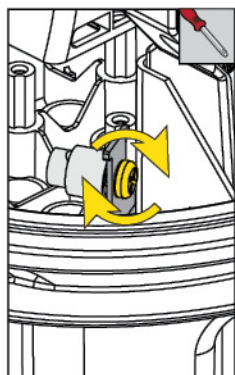
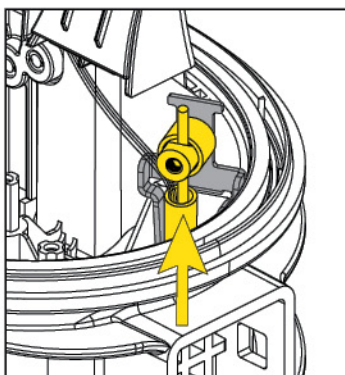
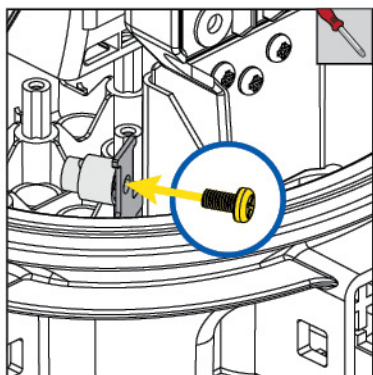

D

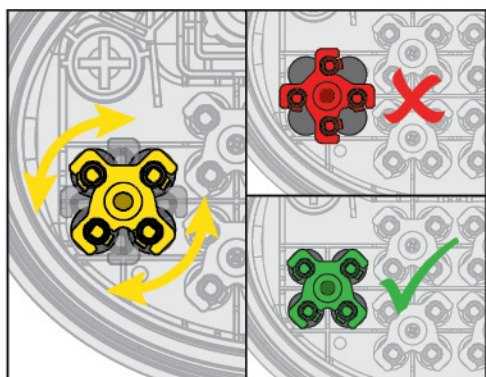
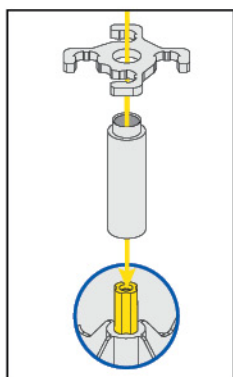
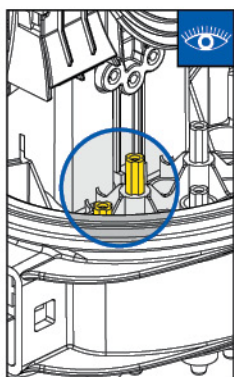
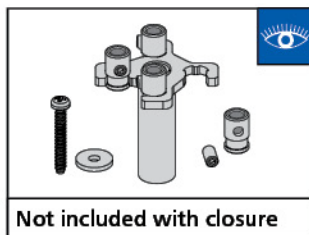
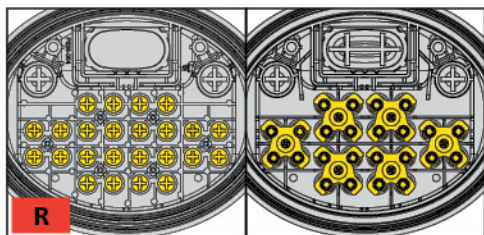

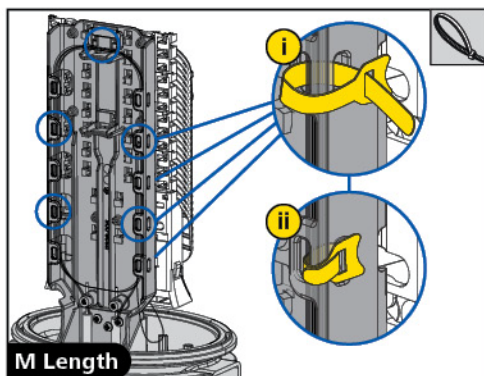
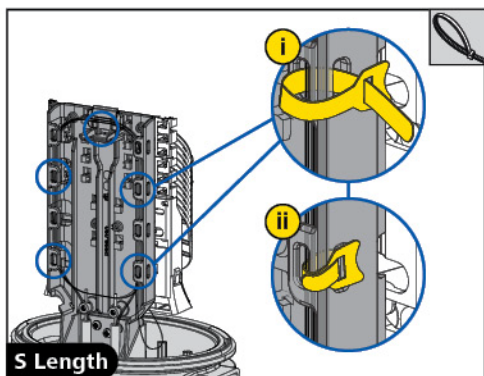

F

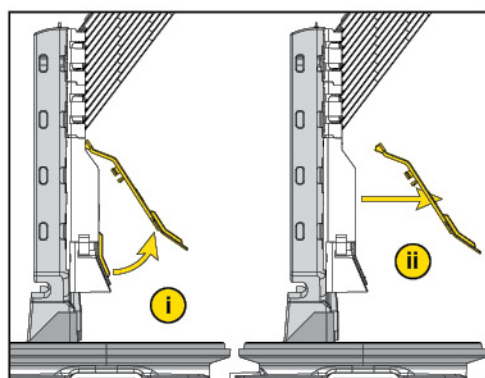
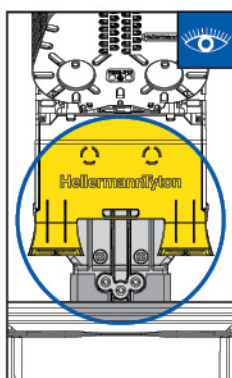
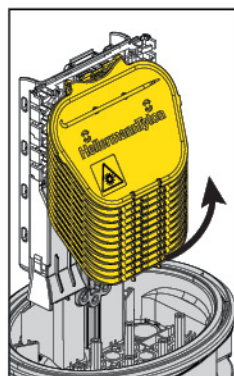
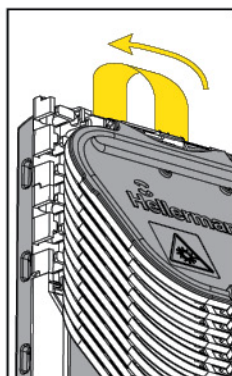
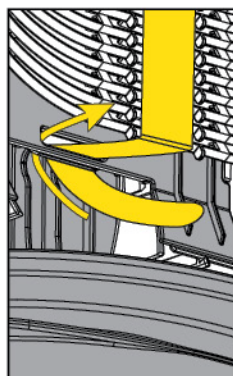
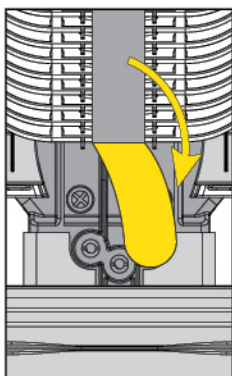

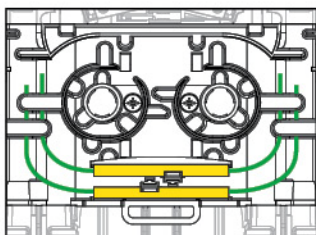
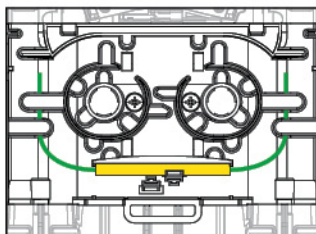
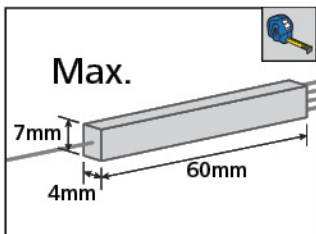
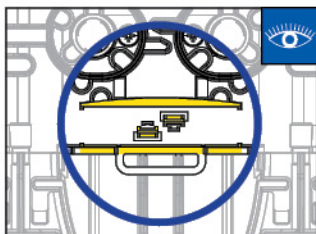
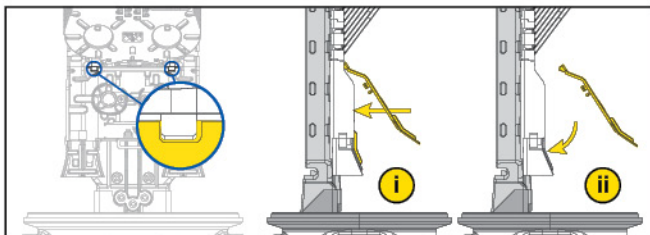
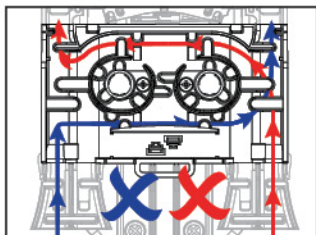
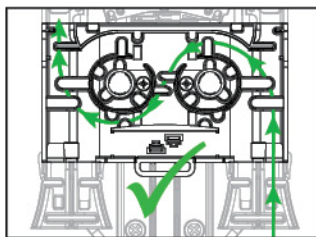
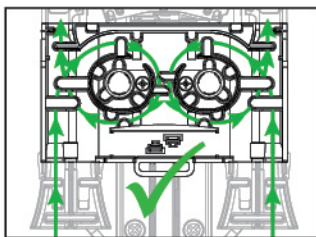
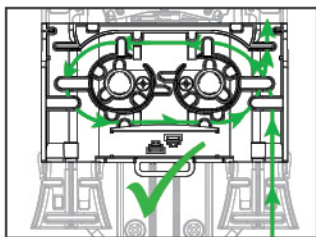

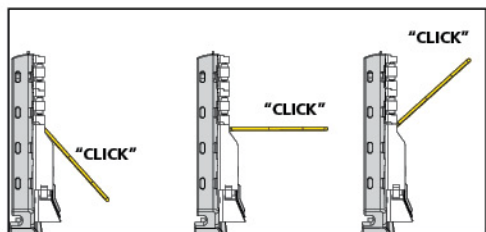
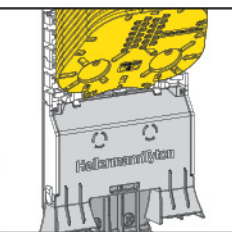
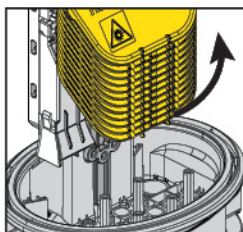
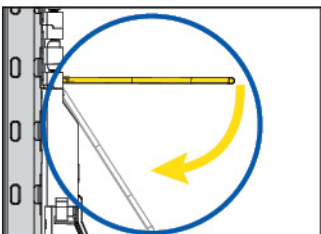
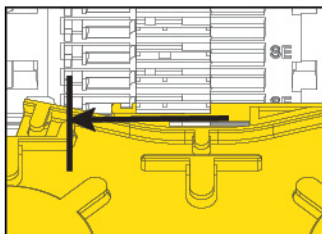
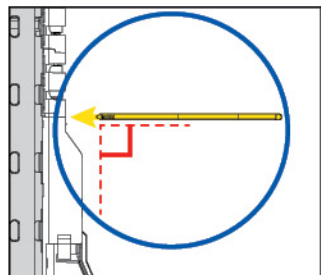
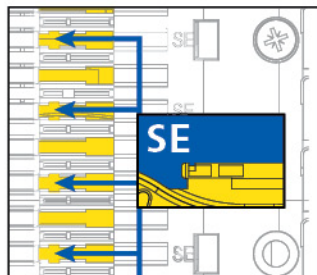
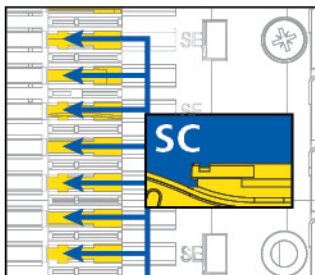
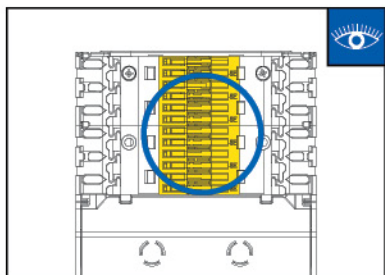
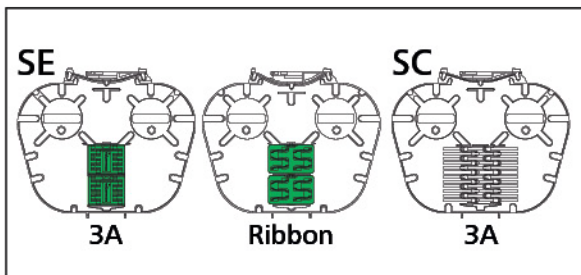

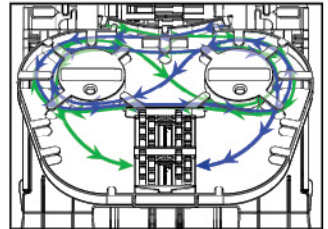
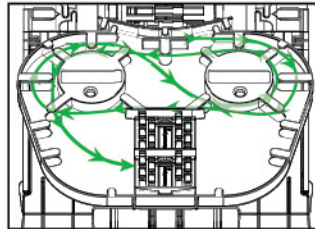
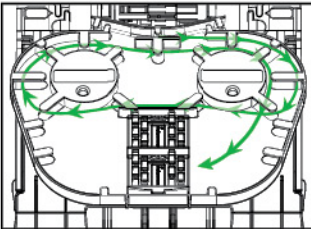
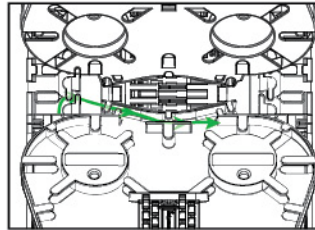
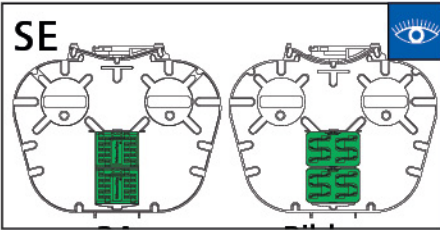
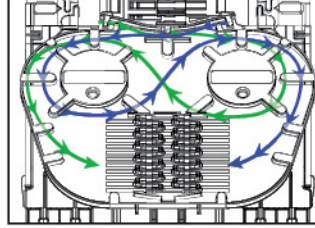
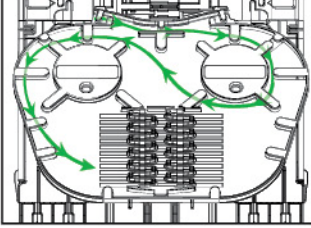
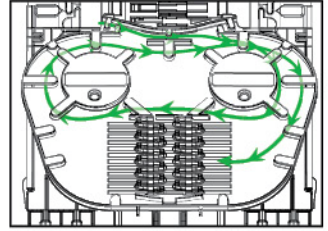
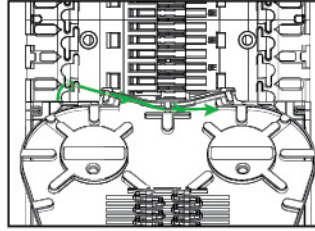
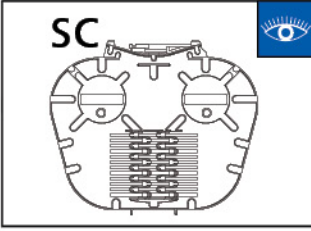

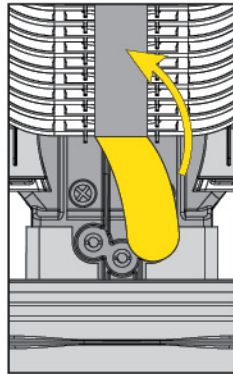
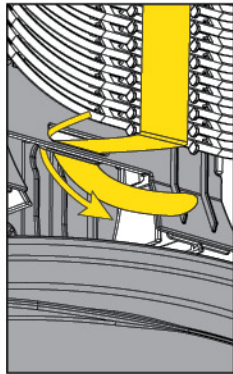
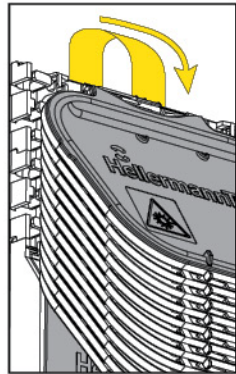
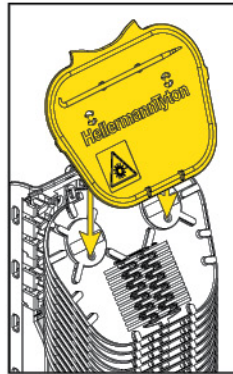
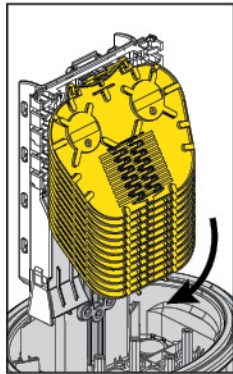
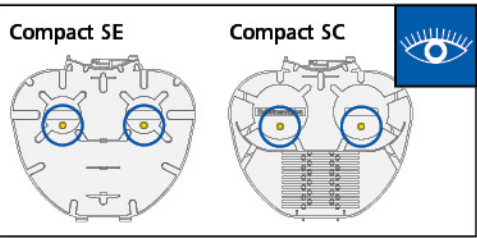
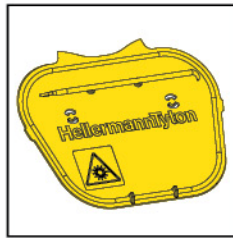
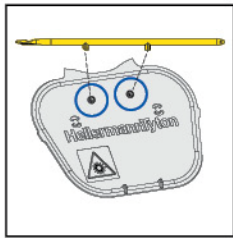

HellermannTyton



 **HellermannTyton Data Ltd – UK**
Tel: +44 (0) 1604 706633
www.htdata.co.uk



 **HellermannTyton – USA**
Tel: 800 537 1512
www.hellermann.tyton.com